

**Table 4: Alarm point for low battery voltage table**

Model	Alarm point
SCC-MPPT-300	10.5 V
SCC-MPPT-600	21.0 V

**Table 5: Charging hour table for reference**

Battery Capacity	To 90% capacity @ 25A charging current
52 Ah	2 hours
100 Ah	4 hours
200 Ah	8 hours
300 Ah	12 hours
400 Ah	16 hours
500 Ah	20 hours

**Table 6: Power consumption of home appliances table\***

Appliances	Power Consumption (W)	Daily usage hours	Daily watt hours used (Wh)
Lighting bulb	60	6	360
Energy saving bulb	13	6	78
Electric fan	60	12	720
TV	100	4	400
Washing machine	800	1	800
Air conditioner	800	6	4800
Freezer	400	24	9600
PC with 17" monitor	150	6	900
Laptop	70	6	420

\*This power consumption table may be different based on different consumer behavior and local electronic specifications.

# SCC-MPPT Solar Charge Controller

## Quick Guide



**SCC-MPPT-300**



**SCC-MPPT-600**

## 1. Introduction

SCC-MPPT solar charge controller uses PWM-based DSP controller to keep the batteries regulated and prevent batteries from overcharging and discharging. Applying intelligent MPPT algorithm, it allows SCC-MPPT solar charge controller to extract maximum power from solar arrays by finding the maximum power point of the array.

The solar charge controller facilitates a standalone energy system. Typical applications are listed below:

- Mobile applications such as moving van, lodge, log cabin, or night market.
- Lighting applications such as street lights, road lights, or garage lights.
- Remote village with power shortage

## 2. Product Overview

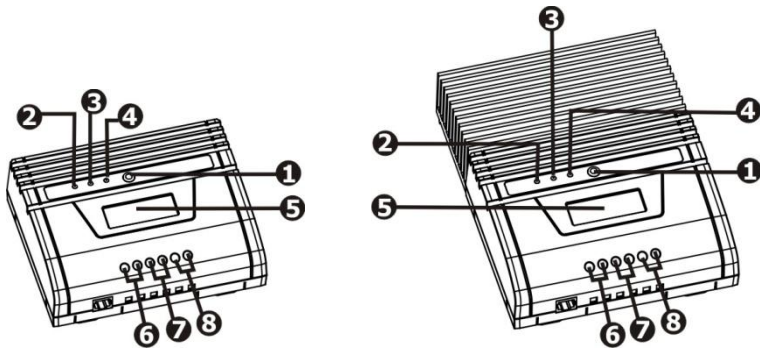

- 1 Power switch
- 2 Solar energy status indicator (Blue LED)
- 3 Charging status indicator (Green LED)
- 4 Site wiring fault indicator (Red/Orange/Yellow LED)
- 5 LCD display (see Operation Section for the details)
- 6 Terminal block for solar panel connection
- 7 Terminal block for battery connection
- 8 Terminal block for load connection

## 3. Installation

### Inspection

Remove the unit from the shipping package and inspect it for damage that may occur during transportation. Notify the carrier and place of purchase if any damage is found.

### Installation Note

- Read all the installation section before beginning installation
- CAUTION! Careful to reduce the risk of dropping a metal tool on the batteries. It could spark or short circuit the batteries and could cause an explosion.
- CAUTION! Remove personal metal items such as rings, bracelets, necklaces, and watches when working with batteries. Batteries can produce a short circuit current high enough to make metal melt, and could cause severe burns.
- CAUTION! Avoid touching eyes while working near batteries.
- CAUTION! Have plenty of fresh water and soap nearby in case battery acid contacts skin, clothing, or eyes.
- Explosive battery gasses may be present during charging . be certain there is sufficient ventilation to release the gasses.
- CAUTION! NEVER smoke or allow a spark or flame in vicinity of a battery.
- Do not expose this charger controller to rain, snow or liquids of any type.
- WARNING! Provide ventilation to outdoors from the battery compartment. The battery enclosure should be designed to prevent accumulation and concentration of hydrogen gas at the top of the compartment.
- CAUTION! Use insulated tools to reduce the chance of short-circuit when installing or working with the inverter, the batteries, or other equipments attached to this unit.
- CAUTION! For battery installation and maintenance, read the battery manufacturer's installation and maintenance instructions prior to operating.
- Only charge Sealed Lead Acid, Vented Lead, NiCd or Gel batteries.
- CAUTION! To reduce risk of injury, only use qualified batteries from qualified distributors or manufacturers. Any unqualified batteries may cause damage and injury. Do NOT use old or overdue batteries. Please check the battery type and date code before installation to avoid damage and injury.
- WARNING! It's very important for safety and efficient operation to use appropriate external battery cable. To reduce risk of injury, external cables including battery cables, PV panel cables and load connected cables should be UL certified and rated for 75° C or higher. And strongly suggest not to use copper cables less than 12AWG. Below is the external battery cable reference according to system requirements.

Model	Nominal Battery Voltage	Typical Current (Amp)
SCC-MPPT-300	12 V	25 A
SCC-MPPT-600	24 V	25 A

**NOTE:** It's recommended to allow experienced personnel to install solar panel because the efficiency of solar energy transmission is directly effected by installation angles. Please follow the voltage requirement of the unit to wire connection with solar panel and batteries

## Mounting

### Step 1: Choose mounting location

Locate the solar charger controller on a vertical surface. Select an appropriate mounting location. Use a horizontal line and the length of the line must be 150mm and mark the two ends on the wall. (see Fig. 1 & Fig. 3)

### Step 2: Check the clearance

Install the solar charge controller in a protected area that is free of excessive dust and has adequate air flow. Please place the solar charge controller away from other units at least 20 cm to avoid interference. Do NOT operate it where the temperature and humidity is outside the specific limits. (Please check the specs for the limitations.)

### Step 3: Drill the holes

Remove the controller and drill 2 holes in the marked locations with 2 screws.

### Step 4: Secure controller

Place the unit on the surface and align the mounting holes with 2 screws in step 3. (see Fig. 2 & Fig. 4)

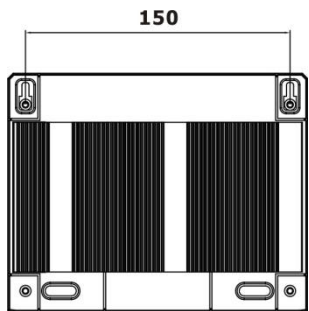

Fig. 1

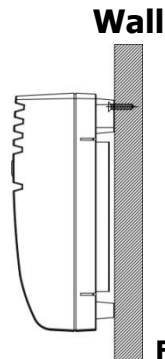

Fig. 2

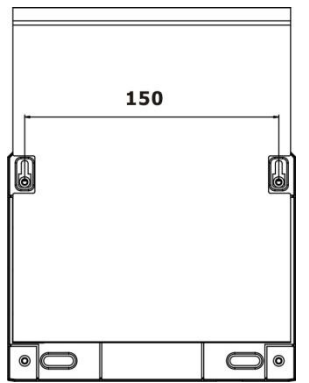

Fig. 3

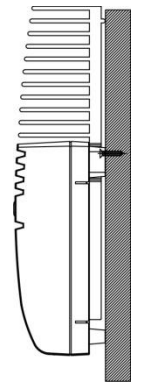

Fig. 4

## Wiring

**CAUTION!** Be sure to secure all wiring, especially for mobile applications. Use cable clamps to prevent cables from swaying when the vehicle is in motion. Unsecured cables create loose and resistive connections which may cause excessive heating or fire

### Step 1: DC Load Wiring

The load output will provide battery voltage to connected loads such as lights, pumps, monitors and other electronic devices.

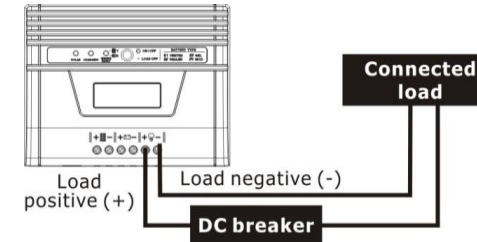

**Step 1:** connect load positive (+) wire to the positive terminal of the unit and load negative (-) wire to the negative terminal of the unit.

**Step 2:** install a DC Breaker or a DC fuse holder in a positive wire. The rating of the DC Breaker/Fuse must be according to the charging current (40 Amp). Keep the DC breaker off or do not install the DC fuse.

**WARNING!** Please use the appropriate cable size according to load rating. Please refer to Important Safety Warnings Section for the details. It will prevent internal high temperature.

### Step 2: Battery Wiring

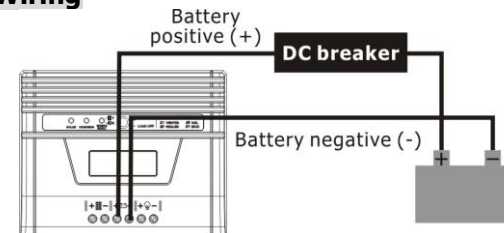

**Step 1:** connect battery positive (+) wire to the positive terminal of the unit and load negative (-) wire to the negative terminal of the unit.

**Step 2:** install a DC Breaker or a DC fuse holder in a positive wire. The rating of the DC Breaker/Fuse must be according to the charging current (40 Amp). Keep the DC breaker off or do not install the DC fuse.

- 1) Multiple batteries in series connection (Refer to Fig. 5):** All batteries must be equal in voltage and amp hour capacity. The sum of their voltages must be equal to the nominal DC Voltage of the unit.

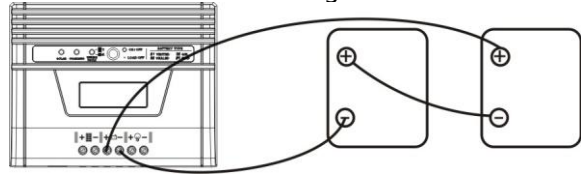

**Fig. 5**

- 2) Multiple batteries in parallel connection (Refer to Fig. 6):** Each battery's voltage must be equal to the Nominal DC Voltage of the unit.

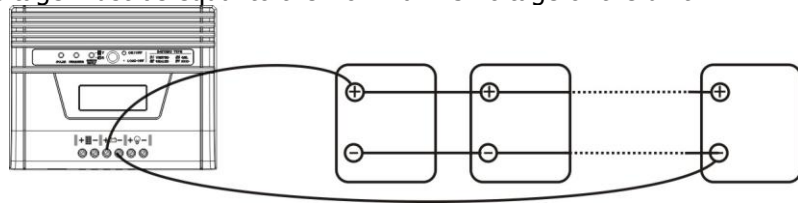

**Fig. 6**

### Step 3: Solar Module Wiring

**WARNING:** Risk of electric shock! Exercise caution when handling solar wiring. The solar array high voltage output can cause severe shock or injury. Cover modules from the sun before installing solar panel wiring.

**Step 1:** connect positive (+) wire of solar module to the positive terminal of the unit and negative (-) wire of solar module to the negative terminal of the unit.

- 1) Single solar module connection (Refer to Fig. 7):** When using a single solar module, its voltage must be equal to the Nominal DC Voltage of the unit (see below Table 1).

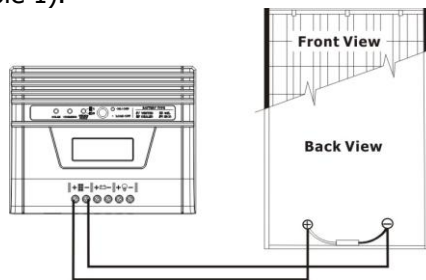
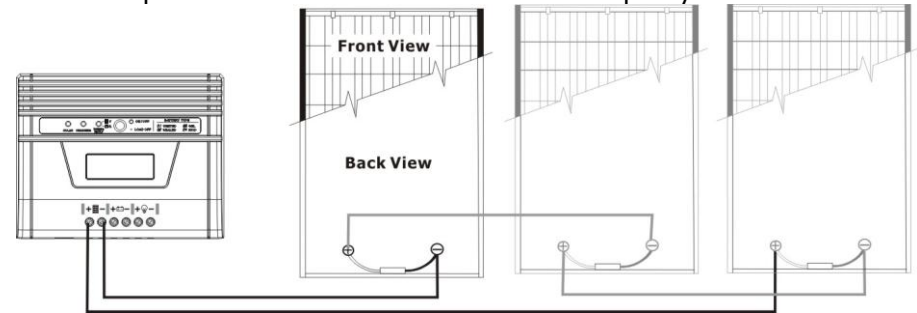

**Fig. 7**

**Table 1:**

Model	Nominal DC Voltage	Maximum Solar Module Power
SCC-MPPT-300	12 VDC	300 W
SCC-MPPT-600	24 VDC	600 W

- 2) Multiple solar modules in series connection (Refer to Fig. 8):** All modules must be equal in voltage and amp hour capacity. The sum of their voltages must be equal to the nominal DC Voltage of the unit. And, the sum of their solar power must not exceed the maximum capacity of the unit.



**Fig. 8**

- 3) Multiple solar modules in parallel connection (Refer to Fig. 9):** Each module's voltage must be equal to the Nominal DC Voltage of the unit. And, the sum of their solar power must not exceed the maximum capacity of the unit.

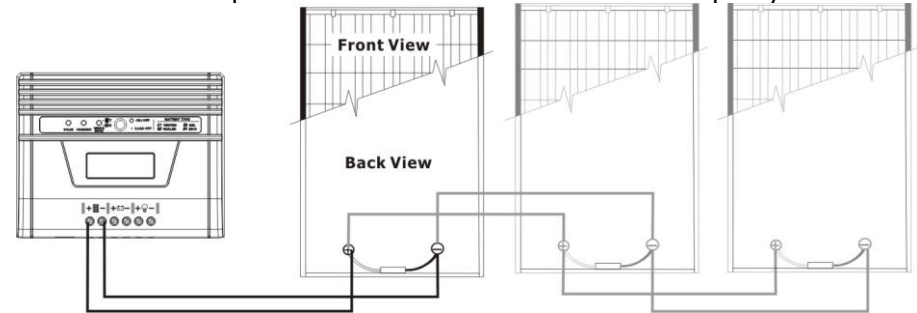

**Fig. 9**

**CAUTION:** It may not cause any damage to solar module or unit when connecting polarity reversals. However, the unit will not be able to work normally.

**WARNING!** Please use the appropriate cable. Please refer to Important Safety Warnings Section for the details.

**WARNING!!** Once solar module energy is above 15 V, it will automatically wake up the charge controller and the charge controller will detect battery and loads automatically. When the charge controller is not connected to battery, it will alarm for reminding.

### Step 4: Switch on DC breaker or install DC fuse

After completing all wires, double check if all wires are connected well. Then switch on DC breaker or install DC fuse on. Take off the cover of solar module. When the solar module power is above 15V, the charger will automatically turn on to work.

#### 4. Operation

After all wires are connected, the solar charge controller will automatically work. At this time, the blue LED will light up and LCD display panel will show information.

#### Switch Operation

The switch has three modes during operation:

Activate LCD backlight	Press button for less than 1 second
Select battery type*	When the unit starts to work, press button for 1-3 seconds to select battery type. D1: vented battery D2: sealed lead acid battery D3: Gel battery D4: NiCd battery
Mute	Press button > 3 seconds

\*Please carefully to select battery type. It will damage battery if the setting is incorrect. Refer to charging voltage table in the appendix.

#### Status, LED/LCD Display and Audible Alarms

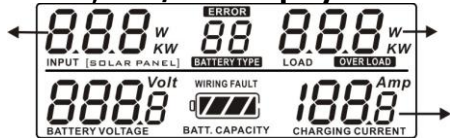

Status	LCD	LED	Alarm
Polarity reversal on solar module connection.	N/A	Yellow LED on.	N/A
Polarity reversal on battery connection.	N/A	Red LED on.	N/A
Polarity reversal on battery and solar module connection.	N/A	Orange LED on.	N/A
Battery is in charging.		Blue & Green LEDs on.	N/A.
Low battery voltage.*	 Flashing every sec.	N/A	Sounding every sec
110% overload.	 OVERLOAD Flashing every 2 secs.	N/A	Sounding every 2 secs. for 5 min. Then continuously sounding.

\*Refer to alarm point for low voltage table in appendix.

#### Fault and error codes table:

Status	LCD	LED	Alarm
Battery defect. There is power input from solar module, but battery voltage is too low. 12V system: < 8.5V 24V system: < 17V		Green LED on.	Continuously sounding.
Overcharge and the charger will automatically cut off output.		Blue LED on	Continuously sounding.
130% overload and the charger will automatically cut off output.		N/A	Continuously sounding.
When solar input voltage is too high, the charger will automatically cut off charging.		Blue LED flashes every second	N/A

#### 5. Specifications

Model	SCC-MPPT-300	SCC-MPPT-600
<b>INPUT</b>		
MPPT Range @ Operating Voltage	15 V ~ 33 V @ 12 V	30 V ~ 66 V @ 24 V
Maximum PV Array Open Circuit Voltage	50 V	75 V
Maximum PV Array Power	300 W	600 W
Maximum Current	18 A	
<b>OUTPUT</b>		
Nominal Battery Voltage	12V	24V
Connected Battery Type	Sealed lead acid, vented, Gel, NiCd battery	
Maximum Charging Current	25 A	
Standby Power Consumption	2 W	
Charging Method	Three stages: bulk, absorption, and floating	
<b>PHYSICAL</b>		
Dimension (DxWxH mm)	135 x 170 x 57.5	200 x 170 x 57.5
Net Weight (kgs)	0.92	1.85
<b>ENVIRONMENT</b>		
Humidity	0-100 % RH (non-condensing)	
Operating Temperature	-20°C - 55°C	
Storage Temperature	-40°C - 75°C	

## 6. Trouble Shooting

Problem	Possible Cause	Solutions
Yellow LED on	Polarity reversal on solar module connection.	Reconnect polarity again
Red LED on.	Polarity reversal on battery connection.	Reconnect polarity again.
Orange LED on.	Polarity reversal on solar module and battery connection.	Reconnect polarity of solar module and battery again.
No solar energy input during daytime.	Wires are not firmly connected.	Check if all wires are connected properly.
	Solar module defect.	Check solar modules or call local dealer to replace solar modules.
F0 fault code displays on LCD panel	Battery wires are not connected well.	Check if battery wires are properly connected.
	Battery defect.	Replace battery.
Backup time is shorter.	Battery defect.	Check battery life cycle and replace battery.
	Overload.	Remove excess loads.
F1 fault code displays on LCD panel.	Battery wires are not connected well.	Check if battery wires are properly connected.
	Battery defect.	Replace battery.
	Charge controller defect.	Replace the unit.
F2 fault code displays on LCD panel.	Overload.	Remove excess loads.
E1 fault code displays on LCD panel.	Solar input voltage is too high.	Check if solar wiring is correct. And then check solar input voltage.

If there is any abnormal situations occur which doesn't list above, please call the service people immediately for professional examine.

## APPENDIX

**Table 1: Recommended minimum battery cable size versus length**

Model	Nominal battery Voltage	Charging Current	1 meter (one-way)	Dia-mm
SCC-MPPT-300	12 V	25 A	AWG 12	2.0525
SCC-MPPT-600	24 V	25 A	AWG 12	2.0525

**Table 2 External Battery Cable Size Reference**

AWG (American Wire Gauge Size)	Dia-mm (Diameter in millimeters)	Ohms/Kft (Ohms per 1,000ft or 304.8 meter)
0000(4/0)	11.684	0.049
000(3/0)	10.405	0.0618
00(2/0)	9.2657	0.0779
0(1/0)	8.2513	0.0983
1	7.348	0.1239
2	6.5436	0.1563
3	5.8272	0.197
4	5.1893	0.2485
5	4.6212	0.3133
6	4.1153	0.3951
7	3.6648	0.4982
8	3.2636	0.6282
9	2.9063	0.7921
10	2.5881	0.9989
11	2.3048	1.2596
12	2.0525	1.5883

**Table 3: Charging voltage for 4 types of battery**

Battery Type	Battery Type Code	SCC-MPPT-300		SCC-MPPT-600	
		Bulk Voltage	Floating Voltage	Bulk Voltage	Floating Voltage
Vented	01	14.3 V	13.2 V	28.6 V	26.4 V
Sealed	02	14.3 V	13.4 V	28.6 V	26.8 V
Gel	03	14.3 V	13.7 V	28.6 V	27.4 V
NiCd	04	14.3 V	14.0 V	28.6 V	28.0 V